

2010-11 BORG SERIES

77EDII, 101EDII, 125SD, miniBORG 45EDII, 50, 60ED

BORG series



mini BORG series

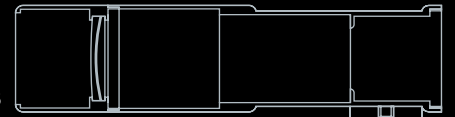

BORG SERIES 2010-2011

INDEX



71FL + E3
Noboru Nakagawa

• 0000 - 5000

0037	6x30 Finder.....	12
3101	Single Fork Mount.....	13
3105	Camera Mount Adapter.....	13
3108	Dovetail Plate.....	13
4317	Helical Focuser S.....	2
4603	2.2x Barlow.....	10
4604	Metal Extension Tube.....	10
4605	1.25" to 0.965" AD.....	10
5002	Pentax K Mount AD.....	3,5
5003	Nikon Mount AD.....	3,5
5004	Canon FD Mount AD.....	3,5
5005	Canon EOS Mount AD.....	3,5
5006	Minolta MD Mount AD.....	3,5
5007	Sony Alpha Mount AD.....	3,5

• 7000

7000	SLR Camera Mount Adapter.....	5
7025	80φ L25mm Tube.....	11
7050	80φ L50mm Tube.....	11
7057	Iris M57.....	14
7060	Tube Band 60φ (a pair).....	12
7061	Tube Band 60φ (a piece).....	12
7083	Tube Band MDX 80φ.....	12
7130	Front Focuser Set.....	11
7135	135mm Tube and Drawtube Set.....	11
7136	80φ L135mm Tube.....	11
7137	Drawtube for 7136.....	11
7150	80φ L150mm Tube.....	11
7157	EOS→M57 AD.....	3
7158	NK→M57 AD.....	3
7159	PK→M57 AD.....	3
7163	Nikon Scope to M57 AD.....	13
M57	Drawtube.....	10
7214	1.4x Teleconverter DG.....	12
7215	1.4x Teleconverter GR.....	12
73001	M75P1.25→M77.6P0.75 AD.....	14
73002	M77.6P0.75→M75P1.25AD.....	14
7314	1.25" Eyepiece Holder S.....	10
7315	1.25" Helical Focuser S.....	2
7316	1.25"→M36.4 AD.....	10
7317	1.25" Eyepiece Holder.....	10
7352	M57 Rotating Ring DX.....	14
7356	1.25"→M57/60 AD.....	7
7357	M57 Metal Cap.....	11
7358	Desiccant Holder.....	11
7360	M43P0.75→M57/60 AD.....	9
7361	M36.4P1 Metal Cap.....	1
7362	M36.4→M57/60 AD.....	9
7364	M57→M36.4 AD.....	9
7396	2"→1.25" ADIII.....	10
7397	2"→1.25" AD.....	10
7401	M57→M28 AD.....	6
7402	M57→M30 AD.....	6
7403	M57→M37 AD.....	6
7404	M57→M43 AD.....	6
7405	M57→M52 AD.....	6
7406	M57→M55 AD.....	6
7407	M57→M58 AD.....	6
7408	M57→M49 AD.....	6
7409	M57→M30.5 AD.....	6

5008	Olympus Mount AD.....	3,5
5009	Yashica & Contax Mount AD.....	3,5
5010	Four Thirds Mount AD.....	3,5
5011	Micro Four Thirds Mount AD.....	3,5
5405	Padded Carrying Bag M.....	14
5409	Padded Carrying Bag L.....	14
5501	80φ Plastic Tube Holder.....	12
5502	Adapter E.....	13
5503	5501/5502 Set.....	12
5504	Takahashi Mount Screw Set.....	13
5556	Camera Accessory Clamp.....	14
5602	End Cap for Series 80 Objectives.....	11
5610	101 Objective Cap.....	11
5612	125ED Objective Cap.....	11

7410	SD-1X Eyepiece Projection AD.....	5
74101	SD-1X(A).....	7
74102	SD-1X(B).....	7
7413	SD-1X(C).....	7
7414	SD-1X(D).....	7
7416	M57→M36.4P0.75 AD.....	7
7423	M42P0.75→M36.4/42P0.75 AD.....	9
7424	SCT→M57/60 AD.....	9
7425	2"→M57/60 AD.....	10
7428	SCT→M68.8 AD.....	9
7430	M43P0.75 AD.....	9
7457	M57→M57 AD.....	9
7458	M57→M57 ADII.....	9
7459	M57→M57 ADIII.....	9
7460	M60→M60 AD.....	9
7500	M6 Cap Screw.....	8
7501	2" Holder SSII.....	8
7502	M57→2" SCT AD.....	9
7504	2" Holder SII.....	8
7505	2" Holder M.....	8
7506	2" Holder SS.....	8
7507	M68.8→M57 AD.....	9
7508	2" Holder S.....	8
7509	2" Holder L.....	8
7510	M60→M57 AD.....	9
7511	1.25"→C Mount AD.....	14
7513	Double Mounting Tube.....	14
7518	Filter Holder.....	14
7519	M57 Filter Box.....	14
7522	M57→M36.4/42 AD.....	9
7523	M57→M42P1 AD.....	9
7524	M42P1→M57/60 AD.....	9
7525	M42P1→M36.4/42 P1.....	9
7526	M42P1→C Mount AD.....	3
7527	C Mount→M42P1 AD.....	3
7528	M42P0.75→M57 AD.....	9
7601	M57/60 Extension Tube SS.....	8
7602	M57/60 Extension Tube S.....	8
7603	M57/60 Extension Tube M.....	8
7604	M57/60 Extension Tube L.....	8
7607	M57/60 Extension Tube SV.....	8
7615	60φ L153mm Tube.....	11
7616	60φ M57 to M57 AD.....	11
7704	ED F4 Super Reducer.....	12

5660	60φ Cap.....	11
5676	77 Objective Cap.....	11
5680	80φ Cap.....	11

7749	Drawtube Holder.....	11
77531	Drawtube.....	11
7755	Dovetail Base.....	11
7757	M57 Helical Focuser S.....	2
7758	M57 Helical Focuser DX.....	2
7800	80φ L205mm Tube.....	11
7801	M77.6→M68.8 AD.....	11
7835	Helical Focuser M.....	2
7839	M42(T-thread) Helical Focuser.....	2
7840	M42 Helical Focuser S.....	3
7841	M42 Helical Focuser L.....	3
7842	M42 Helical Focuser.....	3
7843	M42P1→M49.8 AD.....	3
7844	M42P1→M39 AD.....	3
7847	M42 Extension Tube M.....	3
7850	M39→1.25" AD.....	3
7852	M42P1→M39 ADII.....	3
7855	M42P0.75→M42P1 AD.....	9
7856	M42P1→M42P0.75 AD.....	9
7857	M57 Helical Focuser.....	2
7858	M42 Extension Tube SSS.....	3
7860	M57 Helical Focuser L.....	2
7866	0.66x Triplet Reducer DGT.....	12
7878	0.78x Triplet Reducer.....	12
7885	0.85x Mini Borg Reducer.....	12
7887	0.85x Reducer.....	12
7901	M60→M57/60 AD (Vixen).....	7
7910	M47→M57/60 AD (Takahashi).....	7
7911	M56→M57/60 AD (Takahashi).....	7
7912	M72→M57/60 AD (Takahashi).....	7
7914	M56→M57/60 ADII.....	7
7920	M49.8→M57 AD.....	14
7921	M49.8 Extension Tube S.....	5
7922	M49.8 Extension Tube M.....	5
7923	M57→M49.8 AD SS.....	5

• 8000th

8167	4" Helical Focuser.....	2
8295	115φ L295mm Tube.....	13
8318	Drawtube N.....	13
8360	115φ L360mm Tube.....	13
8567	Pentax 67 Mount AD.....	13
8751	115φ Finder Base Tube N.....	13

• Other

EMS-S	Erecting Mirror Diagonal.....	14
FTF-8C	Feather Touch Focuser 2".....	10
FTF-M57	Feather Touch Focuser M57.....	10
FTF-BORG	BORG/FTF AD.....	10



60ED + G1, Tetsuro Ito

Helical Focusers



A: 1.25" sleeve
B: M36.4P1 male

■ Helical Focuser [4317]

●Length: 38-52mm ●Weight: 60g
BORG's most economical helical focuser and the only one with a rotating movement, model [4317] is useful as a supplemental visual focuser that provides fine adjustment for a coarse rack-and-pinion focuser or eliminates the image shift common with standard SCT focusers. The focuser attaches in front via a metric M36.4P1 male thread, but inserts directly into a 1.25" eyepiece sleeve when used with BORG adapter [7316] (which includes threads for 1.25" eyepiece filters).

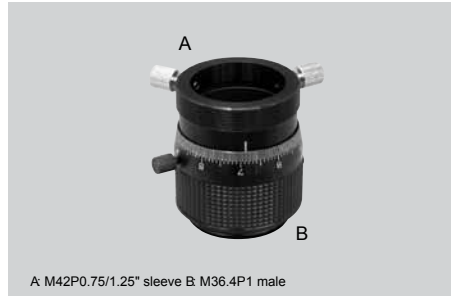

A: M42P0.75/1.25" sleeve B: M36.4P1 male

■ Helical Focuser S [7315]

●Length: 45-55mm ●Weight: 80g
The deluxe version of model [4317], this non-rotating helical focuser includes index marks on the outside of the barrel, which greatly facilitate focusing when switching between CCD camera and eyepiece. In addition to visual use, this focuser also works well for fine focusing of CCD cameras, digital still cameras and video cameras. The front attachment is a metric M36.4P1 male thread, or 1.25" interface when used with adapter 7316. The rear attachment includes a t-thread.



A: M57P0.75 female
B: M57P0.75 male

■ M57 Helical Focuser S [7757]

●Length: 19-29mm ●Weight: 50g ●OD: 67mm ●ID: 50.8mm
BORG's shortest helical focuser, model [7757] works with a variety of adapters for a wide range of interface options. Its short length is useful in accommodating accessories with long focuser requirement, such as diagonals and binoviewers. This model is recommended for visual use only as its short length does not permit a focus lock screw.

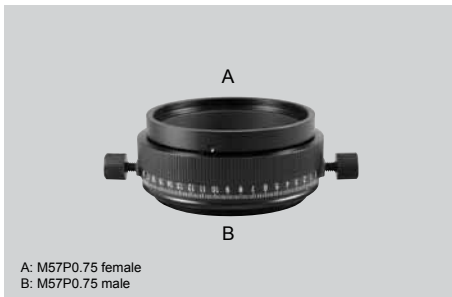

A: M57P0.75 female
B: M57P0.75 male

■ M57 Helical Focuser DX [7758]

●Length: 26-43mm ●Weight: 80g ●OD: 68mm ●ID: 50.8mm
This is a deluxe version of model [7757]. It features index marks and two locking screws, which are useful for imaging applications.



A: M57P0.75 female
M60P0.75 male
B: M57P0.75 male

■ M57 Helical Focuser [7857]

●Length: 49-64mm ●Weight: 165g ●OD: 63mm ●ID: 43mm
A versatile front end interface (M57P0.75 male) allows this focuser to be connected to a wide variety of BORG accessories, including adapters ([7901], [7910], [7911] and [7912]) for third-party scopes, such as Vixen and Takahashi focuser sections. The internal diameter (47mm) is wide enough to cover 35mm format sensors.



A: M60P0.75 male
M57P0.75 female
B: M68.8P0.75 male

■ Helical Focuser M [7835]

●Length: 63-83mm ●Weight: 320g ●OD: 76mm ●ID: 56mm
This focuser is provided standard with Series 80 scopes. BORG adapter [7428] allows this focuser to be attached to an SCT.

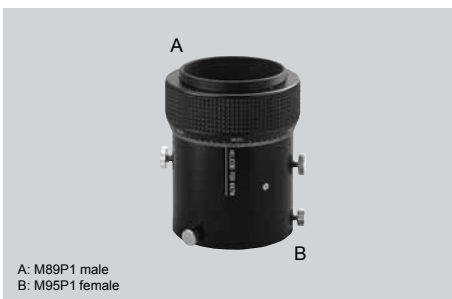

A: M89P1 male
B: M95P1 female

■ 4" Helical Focuser [8167]

●Length: 107-138mm ●Weight: 850g ●OD: 112mm ●ID: 84mm
The largest focuser in the BORG helical focuser family, this fully covers a 6x9 format film frame and is recommended for use with Series 115 tubes.

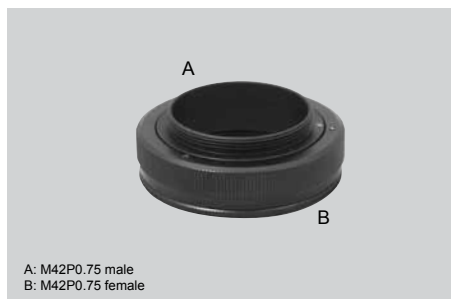

A: M42P0.75 male
B: M42P0.75 female

■ T-thread Helical Focuser [7839]

●Length: 15-25mm ●Weight: 80g ●OD: 60mm ●ID: 39mm
This helical focuser features the T-thread interface common on telescope-camera adapters. The low profile design minimizes the length of light path.

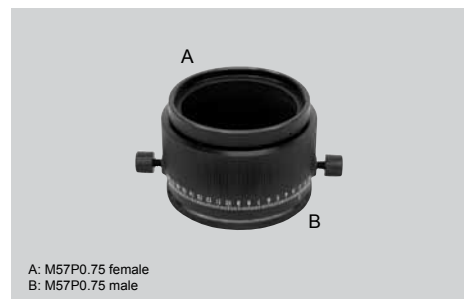

A: M57P0.75 female
B: M57P0.75 male

■ M57 Helical Focuser LII [7860]

●Length: 46-82mm ●Weight: 170g ●OD: 69mm ●ID: 51mm
Longest focus travel in BORG helical focuser family, making this useful for terrestrial photography. This also features the largest internal opening among M57 focusers.



M42 Helical Focusers



A: M42P1 female
B: M42P1 male

■ M42 Helical Focuser L [7841]

●Length: 27-47mm●Weight: 110g●OD: 60mm●ID: 39mm

A long travel (20mm) makes this focuser great for extreme close-ups, or for long focal length lenses such as the Leica L (requires adapter [7844])



A: M42P1 female
B: M42P1 male

■ M42 Helical Focuser [7842]

●Length: 15-25mm●Weight: 80g●OD: 60mm●ID: 39mm

Same as focuser [7841] but with lower profile and shorter travel (10mm)



A: M42P1 female
B: M42P1 male

■ M42 Helical Focuser S [7840]

●Length: 11-18mm●Weight: 60g●OD: 60mm●ID: 39mm

Lowest-profile M42 focuser with the shortest travel (7mm)

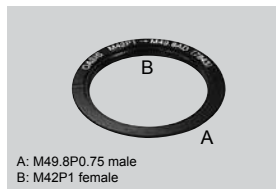

A: M49.8P0.75 male
B: M42P1 female

■ M42P1 to M49.8 AD [7843]

Light Path: 1.5mm
Connects focusers to BORG camera mounts [5002] to [5011]

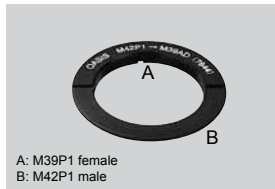

A: M39P1 female
B: M42P1 male

■ M42P1 to M39 AD [7844]

Light path: 1.5mm
Connects Leica L-mount lenses or EL Nikkor enlarger lenses to focusers.

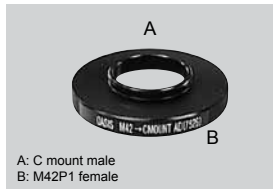

A: C mount male
B: M42P1 female

■ M42P1 to C-Mount AD [7526]

Light path: 6mm
Connects a C-mount camera to an M42 lens via focusers or to BORG telescopes.

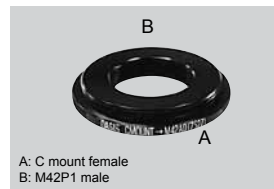

A: C mount female
B: M42P1 male

■ C-Mount to M42P1 AD [7527]

Light path: 3.5mm
Allows the use of a C-mount lens (normally used with a video camera) with an M42P1 camera body.

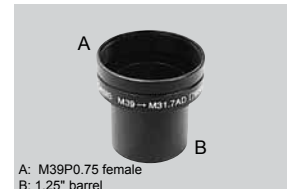

A: M39P0.75 female
B: 1.25" barrel

■ M39 to 1.25" AD [7850]

Allows the attachment of Leica or Nikkor EL lenses to eyepiece focusers such as [4317] and [7315].

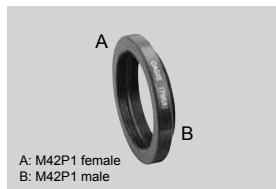

A: M42P1 female
B: M42P1 male

■ M42 Extension Tube SSS [7858]

Light path: 6mm
Shortest extension tube for focusers (new).



A: M42P1 female
B: M42P1 male

■ M42 Extension Tube M [7847]

Light path: 40mm
Long extension tube for focusers.



A: M42P1 female
B: M39P1 male

■ M42P1 to M39 AD-II [7852]

Light path: 17mm
Allows Leica L-mount camera bodies to be attached to M42 lenses.

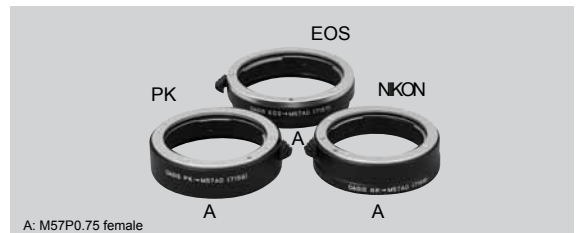

A: M57P0.75 female

■ Camera Lens to M57 AD EOS-M57 [7157] NK-M57 [7158] PK-M57 [7159]

Allows the use of camera lenses with wide variety of BORG M57 accessories.



■ SLR Camera Mount

Part #	Description
[5002]	Pentax K
[5003]	Nikon
[5004]	Canon FD
[5005]	Canon EOS
[5006]	Minolta MD
[5007]	Sony Alpha
[5008]	Olympus
[5009]	Yashica/Contax
[5010]	Four Thirds
[5011]	Micro Four Thirds

M42 Helical Focuser System Chart

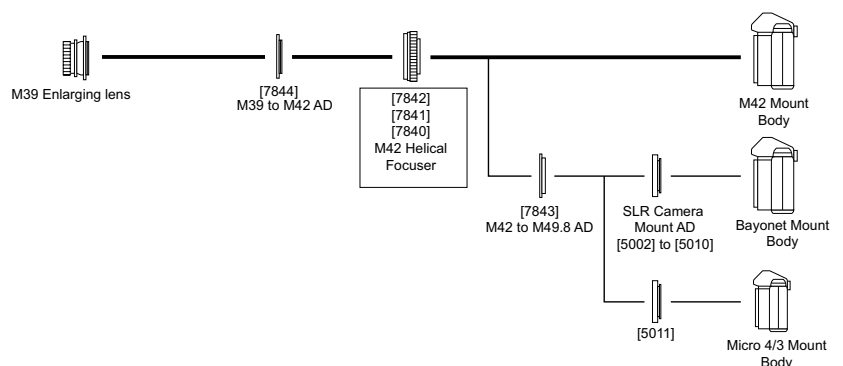

SLR Camera Mount Adapters



E-P1 + [5000] + [7843] + [7840] + [7844] + EL50/F2.8

4 Features of Mount Adapters

1 Attaches Canon EOS, Nikon F, and Pentax K lenses to Micro Four Thirds cameras



GH1 + [5011] + [7923] + [7157] + EF100-400 Lens

Micro Four Thirds body with Canon EF Lens ([5011]+[7923]+[7157]) allows the attachment of Canon EF lenses with Micro Four Thirds cameras for distance imaging. Nikon configuration is [5011]+[7923]+[7158] and Pentax K is [5011]+[7923]+[7159].

2 Quickly switches Borg scopes between imaging and visual configurations.



BORG scope + [7000] + [5005] + [7157] + [7522] + [7317] + 1.25" eyepiece

Quick Change for Visual observing

Allows for quick switching between imaging and visual observing. Images are crisp and clear, though inverted for typical astronomical use.

3 Visual use of telephoto lenses



EF lens + [7157] + [7522] + [7317] + 1.25" eyepiece

Telephoto lenses turn into telescopes

Allows the use of a telephoto lens as a visual telescope. EOS lenses require [7157]+[7522]+[7317] and a 1.25" eyepiece. Nikon lenses require [7158] instead of [7157]. Pentax K lenses require [7159] instead of [7157].

4 Adapts enlarging lenses for imaging with Micro Four Thirds camera



G1 + [5011] + [7843] + [7840] + [7844] + EL50/F2.8

Revives Old Enlarging Lenses

Enlarging lenses are well known as high-resolution optics and allow high quality imaging in conjunction with micro four thirds cameras. An M42 helical focuser is required for focus adjustment.

Mount Adapter System Chart

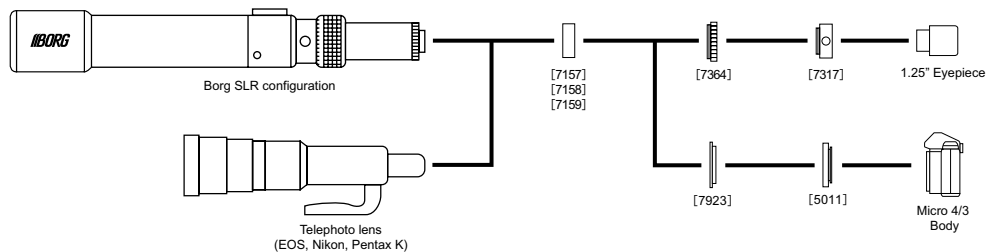

Camera Adapters

45EDII + EOS40D Noboru Nakagawa



■ SD-1X, 1.25" Eyepiece Projection Adapter [7410]

This versatile adapter allows attachment of a digital still camera, digital SLR camera, digital video camera, or film-based SLR camera to a BORG scope. It consists of two sections: the "A" section that holds 1.25" eyepiece, and the "B" section that connects to the camera (via an adapter ring, [7401]-[7409]) Special features include:

- Two-piece construction allows easy switching between visual observing and imaging.
- Rotating design allows adjustment of camera orientation
- Adjustable overall length (18mm total travel) lets you vary the eyepiece-camera distance during afocal (eyepiece projection) imaging, and provides enlarging capability when using an SLR (without a camera lens)
- Supports a wide range of telescopes and cameras (using optional BORG accessories)
- Can hold long eyepieces with optional extension tube

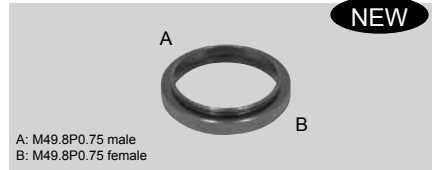

■ M49.8 Extension Tube S [7921]

Light path: 8.2mm
8.2mm long M49.8 extension tube.

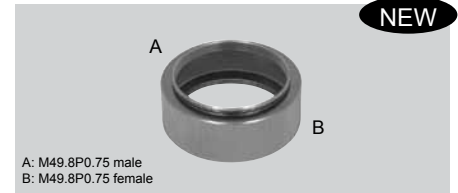

■ M49.8 Extension Tube M [7922]

Light path: 21.5mm
21.5mm long M49.8 extension tube.

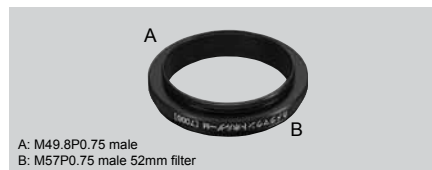

■ SLR Camera Mount Adapter [7000]

Light path: 5mm
Connects SLR camera mounts [5002]-[5011] to BORG telescopes.

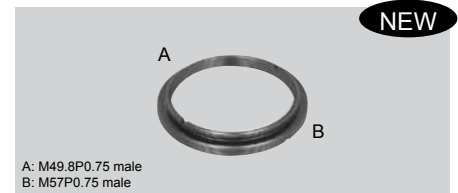

■ M57 to M49.8 ADSS [7923]

Light path: Zero
Useful when adapter [7000] is too long to reach focus.



■ SLR Camera Mount [5002 - 5009]

Allows attachment of SLR cameras to BORG scopes.
Wider internal diameter than the standard T-ring minimizes vignetting.

■ Four Thirds Camera Mount [5010]

Allows attachment of 4/3 format digital cameras to BORG scopes.

■ Micro Four Thirds Camera Mount [5011]

Adapter for micro 4/3 cameras.

Part #	Description
[5002]	Pentax K
[5003]	Nikon
[5004]	Canon FD
[5005]	Canon EOS
[5006]	Minolta MD
[5007]	Sony Alpha
[5008]	Olympus
[5009]	Yashica/Contax
[5010]	Four Thirds
[5011]	Micro Four Thirds



76ED + D300 Masayuki Suzuki

Adapters for Camcorders

Camcorder adapters

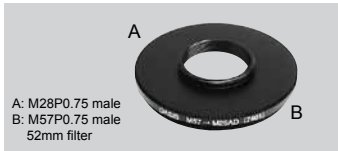

■ **M57 to M28 AD [7401]**
Adapter for 28mm diameter threaded camera.

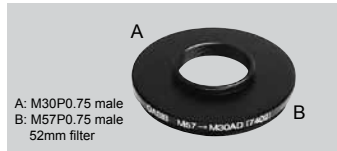

■ **M57 to M30 AD [7402]**
Adapter for 30mm diameter threaded camera.

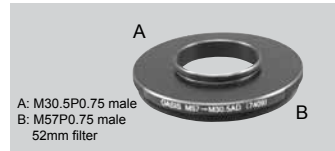

■ **M57 to M30.5 AD [7409]**
Adapter for 30.5mm diameter threaded camera.

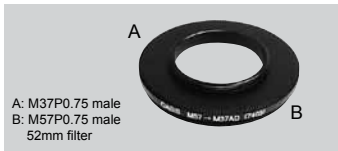

■ **M57 to M37 AD [7403]**
Adapter for 37mm diameter threaded camera.



■ **M57 to M43 AD [7404]**
Adapter for 43mm diameter threaded camera.



■ **M57 to M49 AD [7408]**
Adapter for 49mm diameter threaded camera.



■ **M57 to M52 AD [7405]**
Adapter for 52mm diameter threaded camera.



■ **M57 to M55 AD [7406]**
Adapter for 55mm diameter threaded camera.



■ **M57 to M58 AD [7407]**
Adapter for 58mm diameter threaded camera.

DSLR Cameras



Digital Camcorder





Adapters for 3rd Party Scopes

71FL + D700 Noboru Nakagawa



A: 1.25" sleeve
B: M57P0.75 male 52mm filter

■ **SD-1X(A) [74101]**
Section A of SD-1X (eyepiece holder). Multiple [74101s] allow quick switching of a camera from one telescope to another.



A: M57P0.75 female

■ **SD-1X(B) [74102]**
Section B of SD-1X (camera adapter). Multiple [74102s] allow quick switching between multiple cameras on one telescope.



A: 1.25" sleeve
B: M57P0.75 male

■ **SD-1X(C) [7413]**
SD-1X(A)'s shorter version. reduces the light path by 15mm. Useful when the telescope's back focus is limited.



A: M57P0.75 female

■ **SD-1X(D) [7414]**
SD-1X(B)'s shorter version reduces the light path by 13mm. Useful when the telescope's back focus is limited.

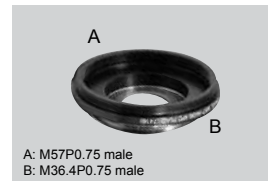

A: M57P0.75 male
B: M36.4P0.75 male

■ **M57 to M36.4P0.75 AD [7416]**
Adapter to connect Nikon E-4300, Sony W1/5/7, Olympus SP350, etc. with BORG scopes. Use with [7601] etc. as a clearance space between the eyepiece and camera's lens.

Adapters for 3rd Party Telescopes



A: M60P0.75male M57P0.75female
B: M56P1 female

■ **M56 to M57/60 ADII [7914]**
Allows attachment of a wide variety of BORG M57 accessories with most Chinese telescopes. Includes a built-in rotator.



A: M60P0.75male M57P0.75female
B: M60P0.75male M57P0.75female

■ **M60 to M57 AD [7911]**
Light path: 3mm
Vixen adapter which allows the use of a wide variety of BORG M57 accessories with Vixen scopes.

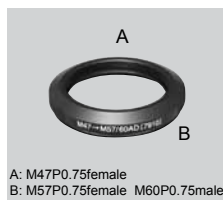

A: M47P0.75female
B: M57P0.75female M60P0.75male

■ **M47 to M57 AD [7910]**
Light path: 8mm
Adapter for Takahashi telescopes which have an M47 threaded section.



A: M56P0.75female
B: M57P0.75female M60P0.75male

■ **M56 to M57 AD [7911]**
Light path: 7mm
FS-60C adapter



A: M57P0.75female M60P0.75male
B: M72P1 male 58mm filter

■ **M72 to M57 AD [7912]**
Light path: 4mm
M72 to M57/60 adapter to Takahashi telescopes such as FS Series, TOA Series, TSA Series and BRC/FRC Series.

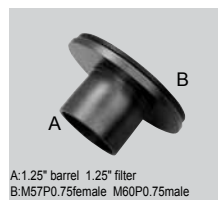

A: 1.25" barrel 1.25" filter
B: M57P0.75female M60P0.75male

■ **1.25" to M57 AD [7356]**
Adapter for connecting BORG parts ([7410], etc.) to a 1.25" eyepiece sleeve.





Extension Tubes & Holders

77EDII + 7704 Masanori Kirimura

M57/60 Extension Tubes



A: M57P0.75 female M60P0.75 male
B: M57P0.75 male

■ **Extension Tube SS [7601]**
Light path: 12mm
53mm Internal diameter. Light weight minimizes need to re-balance telescope.

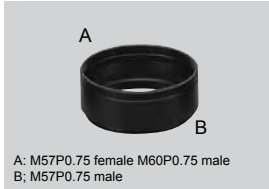

A: M57P0.75 female M60P0.75 male
B: M57P0.75 male

■ **Extension Tube S [7602]**
Light path: 20mm
53mm Internal diameter. Light weight minimizes need to re-balance telescope.

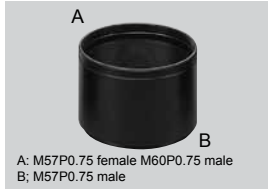

A: M57P0.75 female M60P0.75 male
B: M57P0.75 male

■ **Extension Tube M [7603]**
Light path: 40mm
53mm Internal diameter. Light weight minimizes need to re-balance telescope.

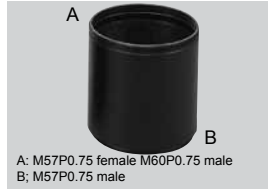

A: M57P0.75 female M60P0.75 male
B: M57P0.75 male

■ **Extension Tube I [7604]**
Light path: 60mm
53mm Internal diameter. Light weight minimizes need to re-balance telescope.

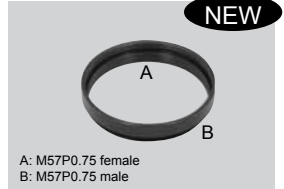

A: M57P0.75 female
B: M57P0.75 male

■ **Extension Tube SV [7607]**
Light path: 7mm
53mm Internal diameter. Light weight minimizes need to re-balance telescope.

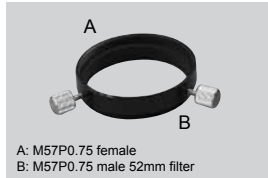

A: M57P0.75 female
B: M57P0.75 male 52mm filter

■ **2" Eyepiece Holder SS [7506]**
Light path: 10mm
2" eyepiece holder with extension tube. Extension tube allows attachment to BORG M57 accessories. 52mm filter thread at the front end.

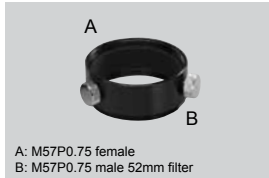

A: M57P0.75 female
B: M57P0.75 male 52mm filter

■ **2" Eyepiece Holder S [7508]**
Light path: 20mm
2" eyepiece holder with extension tube. Extension tube allows attachment to BORG M57 accessories. 52mm filter thread at the front end. Comes standard with Series 80 tube assembly - [6000].



A: M57P0.75 female
B: M57P0.75 male 52mm filter

■ **2" Eyepiece Holder M [7505]**
Light path: 40mm
2" eyepiece holder with extension tube. Extension tube allows attachment to BORG M57 accessories. 52mm filter thread at the front end.

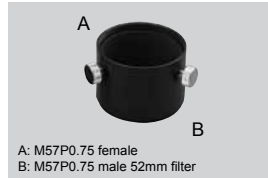

A: M57P0.75 female
B: M57P0.75 male 52mm filter

■ **2" Eyepiece Holder L [7509]**
Light path: 60mm
2" eyepiece holder with extension tube. Extension tube allows attachment to BORG M57 accessories. 52mm filter thread at the front end. Comes standard with Series 80 tube assembly - [6000].



A: 2" sleeve
B: M57P0.75 male

■ **2" Eyepiece Holder SSII [7501]**
Light path: 10mm
Unthreaded back end works well for heavy accessories such as a 2" diagonal.



A: 2" sleeve
B: M57P0.75 male

■ **2" Eyepiece Holder SII [7504]**
Light path: 20mm
Unthreaded back end works well for heavy accessories such as a 2" diagonal.

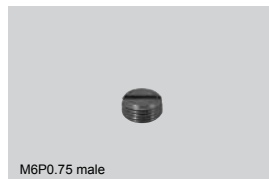

M6P0.75 male

■ **M6 Cap Screw [7500]**
Allows eyepiece holder [7506]/[7508]/[7505]/[7509] to be used as a dedicated extension tube. Replaces set screws and installs flush with outer surface.

Adapters for 3rd-party telescopes

Part #	Description	Telescopes
7424	SCT→M57/60	SCT or SCT-threaded scopes
7910	M47→M57/60AD	Takahashi 60
7911	M56→M57/60AD	Takahashi 76, FS78, SKY90, FS60BC
7912	M72→M57/60AD	Takahashi FC100, 125N, FS102, 128N, FSQ106ED, FSQ85ED, TOA130, TOA150, TSA102, BRC250, TSA120
7914	M56→M57/60AD	Kenko SE80ED, SE102ED, Vixen80SF, ED102SF
7901	M60→M57/60AD	Takahashi MT160, 200, Vixen ED, FL, VISAC
7360	M43P0.75→M57/60AD	Other Takahashi (SKY90, MT100, 130, etc.)
7362	M36.4→M57/60AD	Others via M36.4
7425	2"→M57/60AD	Others via 2"
7356	1.25"→M57/60AD	Others via 1.25"

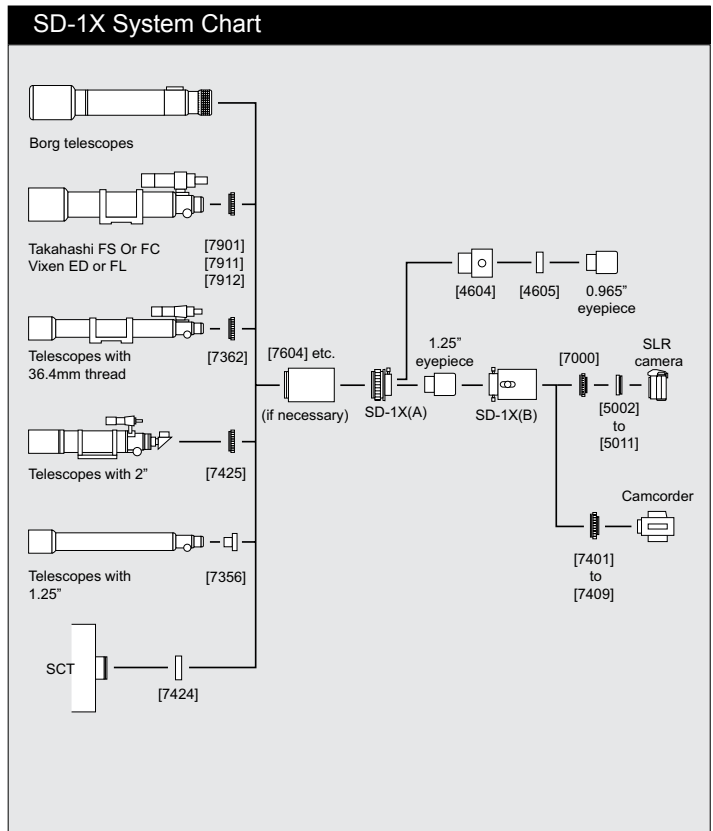



M57/60 Adapters

77edll+K-7 Noboru Nakagawa

M57/60 Adapters



■ **M43 to M57/60 AD [7360]**
Light path: 8mm
Allows the attachment of M43P0.75 threaded (Takahashi) accessories to BORG M57/60 parts.



■ **M36.4 to M57/60 AD [7362]**
Light path: 10mm
Connects BORG parts to telescopes having 36.4mm threads.



■ **M57 to M36.4 AD [7364]**
Light path: 4mm
Converts M57 to M36.4. Light path is 5mm shorter than [7522], allowing greater travel on the inside of focus.



■ **M57 to M57 AD [7457]**
Light path 4mm
Allows the connection of two parts with M57 female threads.

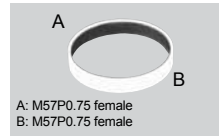

■ **M57 to M57 ADII [7458]**
Light path 10mm
Allows the connection of two parts with M57 male threads.

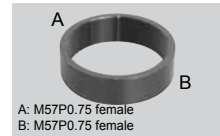

■ **M57 to M57 ADIII [7459]**
Light path: 18mm
Adapter for connecting two M57 male parts. Longer than [7458].

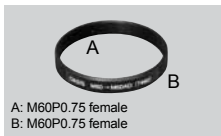

■ **M60 to M60 AD [7460]**
Used to connect two M60 parts.



■ **M57 to 2" AD [7502]**
Light path: 5mm
Allows the connection of SCT accessories to BORG M57/60 parts. Threaded for 52mm filters.



■ **M68.8 to M57 AD [7507]**
Light path: 7mm
Allows the connection of M57 parts directly to a drawtube without needing a helical focuser such as model M [7835] or [FTF-M57].



■ **M60 to M57 AD [7510]**
Light path: 5mm
Converts from M60 to M57 and vice versa. Threaded for 52mm and 55mm filters.



■ **M57 to M36.4/42 AD [7522]**
Light path: 5mm/9mm
Converts M57 to M36.4 and M42P0.75. Allows the connection of popular T-ring or T-thread accessories to BORG scopes. Threaded for 52mm filters.



■ **M57 to M42P1 AD [7523]**
Light path: 5mm/9mm
Converts M57 to M42P1. Use to connect M42 helical focusers to M57 accessories. Threaded for 52mm filter.

M42/43 Adapters



■ **M57 to M43 AD [7430]**
Converts M57 to M43P0.75 (Takahashi accessories). Threaded for 49mm filters.



■ **M42P1 to M57/60 AD [7524]**
Light path: 5mm/9mm
Allows the connection of M57/60 parts behind M42 helical focusers such as [7841] and [7842].



■ **M42P1 to M36.4 AD [7525]**
Light path: 5mm/9mm
Allows the connection of M36.4 parts behind M42 helical focusers such as [7841] and [7842].



■ **M42P0.75 to M36.4/42P0.75 AD [7423]**
Light path: 5mm/11mm
Converts M42P0.75 female to M36.4/42P0.75

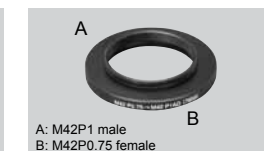

■ **M42P0.75 to M42P1 AD [7855]**
Light path: 6mm
Converts M42P1 to M42P0.75



■ **M42P1 to M42P0.75 AD [7856]**
Light path: 6mm
Converts M42P1 to M42P0.75.



■ **M42P0.75 to M57 AD [7528]**
Light path: 8mm
Allows the connection of BORG parts to T-ring female threads.

SCT Adapters

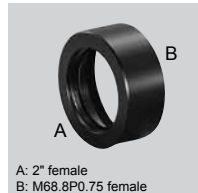

■ **SCT to Helical Focuser AD [7428]**
Light path: 29mm
Allows the attachment of BORG helical focuser [7835] and Feather Touch focusers to an SCT with a 2" threaded opening. This eliminates the mirror shift exhibited by the SCT focuser for more reliable and accurate focusing.



■ **SCT to M57/60 AD [7424]**
Light path: 10mm/14mm
Allows you to attach BORG's wide variety of M57/60 accessories to an SCT with a 2" threaded opening.

Schmidt-Cassegrain System Chart

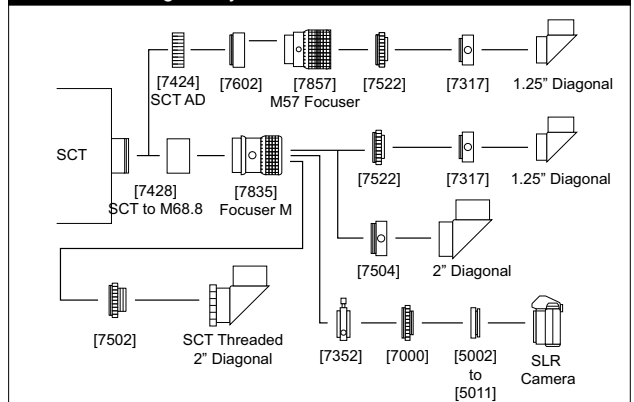



Focusers & Eyepiece Adapters

FL71 + E-3 Noboru Nakagawa

Focusers

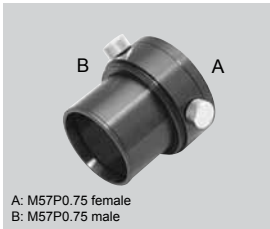

A: M57P0.75 female
B: M57P0.75 male

■ **M57 Drawtube [7205]**
M57 threaded drawtube provides 38mm of focus travel.



A: 2" sleeve

■ **Feather Touch Focuser [FTF-8C]**
Standard Feather Touch focuser with 2" sleeve and compression ring.



A: M57P0.75 female

■ **Feather Touch Focuser M57 [FTF-M57]**
Feather Touch Focuser, threaded for an M57 interface. The M57 threads allow use of the [7704], F4 super reducer.

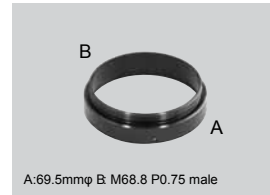

A: 69.5mmφ B: M68.8 P0.75 male

■ **Feather Touch adapter [FTF-BORG]**
Allows attachment of Feather Touch focusers to Series 80 and 115 scopes.

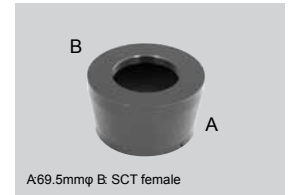

A: 69.5mmφ B: SCT female

■ **Feather/SCT adapter [FTF-SCT]**
Adapter for SCT and Feather Touch focusers.

Eyepiece Adapters



A: 1.25" sleeve
B: 1.25" barrel 1.25"/0.965" filter

■ **2.2x Barlow [4603]**
2.2x barlow lens. Fully multi-coated with two lenses in one group. 1.25" and 0.965" threads allow this barlow to screw directly into an eyepiece like a filter.

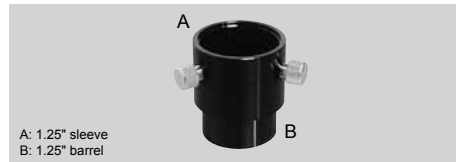

A: 1.25" sleeve
B: 1.25" barrel

■ **Metal Extension Tube [4604]**
Light path: 28mm
28mm long 1.25" extension tube.



A: 0.965" sleeve
B: 1.25" barrel

■ **1.25" to 0.965" AD [4605]**
Converts a 1.25" eyepiece holder for use with 0.965" eyepieces.

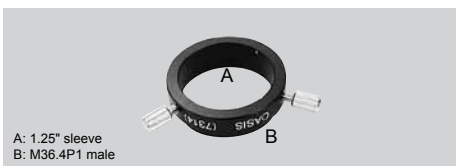

A: 1.25" sleeve
B: M36.4P1 male

■ **1.25" Eyepiece Holder S [7314]**
Light path: 10mm
1.25" low profile eyepiece adapter.

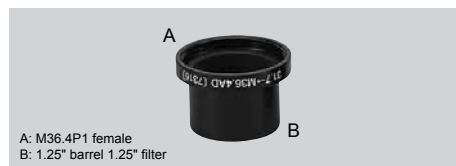

A: M36.4P1 female
B: 1.25" barrel 1.25" filter

■ **1.25" Nosepiece AD [7316]**
Allows insertion of [4317] and [7315] into a 1.25" sleeve.

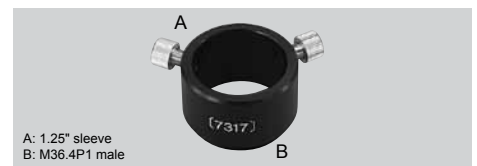

A: 1.25" sleeve
B: M36.4P1 male

■ **1.25" Eyepiece Holder [7317]**
Light path: 20mm
Holds 1.25" eyepieces firmly using two set screws.

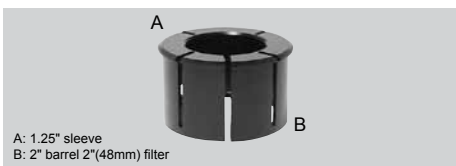

A: 1.25" sleeve
B: 2" barrel 2" (48mm) filter

■ **2" to 1.25" ADII [7396]**
Light path: 2mm
2" to 1.25" adapter with very low profile (2mm long). Holds an eyepiece in place by compression/friction instead of a set screw. The 2" end is threaded for 2" filters.

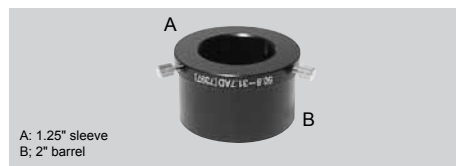

A: 1.25" sleeve
B: 2" barrel

■ **2" to 1.25" AD [7397]**
Light path: 7mm
2" to 1.25" adapter with two set screws to hold an eyepiece in place.

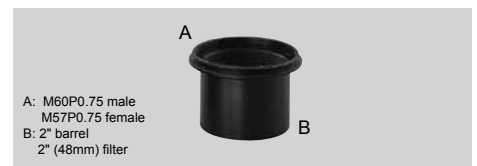

A: M60P0.75 male
M57P0.75 female
B: 2" barrel
2" (48mm) filter

■ **2" Nosepiece AD [7425]**
Allows use of BORG M57 parts with a 2" eyepiece holder.



Tubes, Drawtubes & Lens Caps

FL71 + E-3 Noboru Nakagawa

Tubes

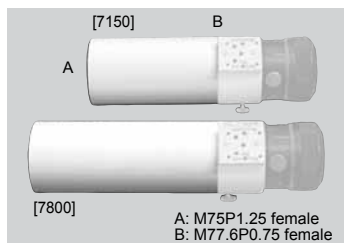

■ **150mm Tube [7150]**
55mm shorter tube than regular [7800] is useful in applications with increased inward focus requirements such as binoviewers.

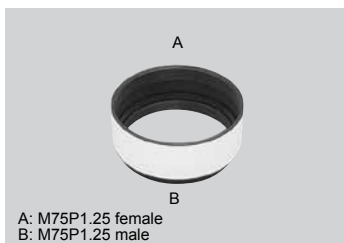

■ **25mm Tube for Series 80 [7025]**
Only 25mm long, this tube can be added in front of the tube assembly [6000]. Helps to minimize the pull-out of a drawtube.

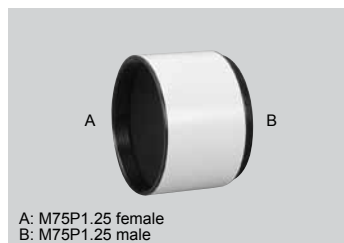

■ **50mm Tube for Series 80 [7050]**
Only 50mm long, this tube can be added in front of the tube assembly [6000]. Helps to minimize the pull-out of a drawtube.

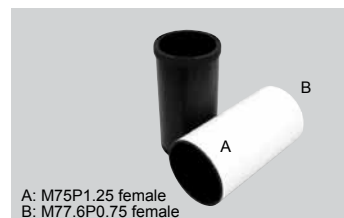

■ **135mm Tube and Drawtube Set [7135]**
This tube set is for the [7704] F4 super reducer set. Each is also separately available as [7136] 135mm tube and as [7137] F4 drawtube.



■ **Front Helical Focuser Adapter Set [7130]**
Allows the placement of the [7835] focuser in front of the tube assembly for improved overall balance. The focuser's motion is thus not affected by the weight of accessories attached at the end of the scope. Good for 77EDII objective (not recommended for 101EDII). Requires addition of [7507] at the end of the scope. Comes with 50mm long tube, M77.6 to M60 AD and M68.8 to M75 AD.

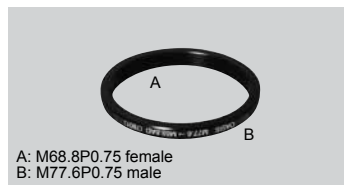

■ **M77.6 to M68.8 AD [7801]**
Allows direct attachment of helical focuser M[7835] and Feather Touch Focusers via [FTF-BORG] to a tube to make the system more rigid and 460g lighter by removing the drawtube holder. 50mm long tube [7050] or M57 drawtube [7205] and 2" eyepiece holder may be added for proper back focus.

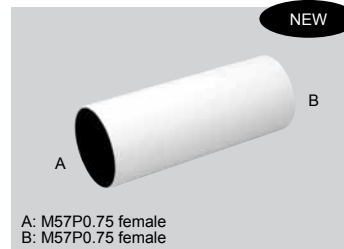

■ **153mm Tube for Mini BORG Series [7165]**
153mm long tube. This can be used in place of the Mini Borg drawtube assembly [6160].

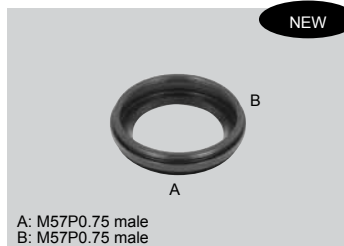

■ **M57 to M57 AD [7616]**
Allows the connection of two Mini BORG 153mm tubes. Includes a 52mm filter thread and baffle inside.



■ **Drawtube Holder and Drawtube Set [7749]**
Included in Series 80 tube assembly [6000].



■ **Standard Drawtube [77531]**
Larger baffle opening drawtube is also available as [77532].

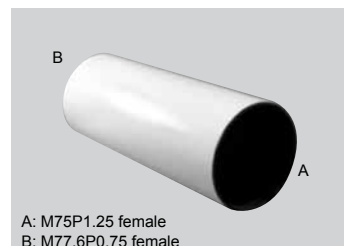

■ **205mm Standard Tube [7800]**
Series 80 standard tube (205mm long)

Caps



■ **M36.4 Metal Cap [7361]**



■ **M57 Metal Cap [7357]**
M49 thread allows attachment of a desiccant holder [7358].



■ **Desiccant Holder [7358]**
When filled with a desiccant (not included), helps to keep excess moisture out of a telescope during storage.

- Front cap for 77EDII objective [5676]
- Front Cap for 101EDII objective [5610]
- End Cap for Series 80 objective [5602]
- Front cap for 125 objective [5612]
- 60φ cap [5660]
- 80φ cap [5680]



Finders, Correction Lenses, Rings

77EDII + D300 Takaaki Kasai

Correction Lenses

■ 1.4X DG Teleconverter [7214]

Optimized for the Mini BORG 45ED to the BORG 101ED, and third-party refractors between 300mm and 640mm focal length. It is specifically designed to minimize internal reflections when photographing bright objects such as the moon, sun, or solar eclipses. Fully multi-coated.



A: M57P0.75 female
B: M57P0.75 male

■ 1.4X GR Teleconverter [7215]

Fully covers up to 35mm full format sensors. Optimized for 500mm to 800mm focal length scopes. It is also specifically designed to minimize internal reflections when photographing bright objects such as the moon, sun, or solar eclipses. Fully multi-coated.

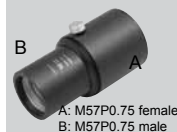

A: M57P0.75 female
B: M57P0.75 male

■ ED F4 Super Reducer [7704]

The quadruplet 0.65x focal reducer set converts the BORG line of scopes into fast astrographs optimized for digital sensors, yet capable of covering a full 35mm frame. The [7704] set includes a built-in filter holder as well as a camera rotator for flexible image composition. Provision for the attachment of filters is via a 55mm diameter filter thread on the front reducer lens assembly (for semi-permanent filter installation) and via a filter holder for easily removed filter carriers which accommodate 52mm or 48mm filters. A camera shutter cable can be attached to the focal reducer assembly to make removal of the filter carrier a simple operation which does not disturb the optical train. Additional filter carriers [7518] are available for quick changes between filters. Fully multi-coated.



Focuser is not included

77EDII + 7704 : 330mm F4.3
101EDII + 7704 : 410mm F4.1
125SD + 7704 : 480mm F3.9

■ Reducer 0.85X DG [7885]

0.85x focal reducer optimized for use with scopes of 250mm to 400mm focal length. Works well with 3rd party scopes such as the Takahashi FS-60C. Fully multi-coated.



A: M49.8P0.75 male
B: M57P0.75 male 52mm filter

45EDII : 276mm F6.1
50Ach : 212mm F4.2

60ED : 298mm F4.9
71FL : 340mm F4.7

■ Reducer 0.85X DGL [7887]

0.85x reducer optimized for use with scopes from 500mm to 1000mm focal length. Suitable for use with 3rd party refractors. Achieves very flat illumination across 35mm full format sensors. Fully multi-coated.



A: M49.8P0.75 male
B: M57P0.75 male 52mm filter

77EDII : 430mm F5.6
101EDII : 540mm F5.3

125SD : 630mm F5.1

■ 0.66x Triplet Super Reducer [7866]

Triplet high quality super reducer for Mini BORG Series. Compatible with 3rd party scopes from 300mm to 500mm. Fully multi-coated.



A: M57P0.75 male 48mm filter
B: M49.8P0.75 male

NEW ■ 0.78x Triplet Super Reducer [7878]

Triplet high quality super reducer, optimized for BORG 77EDII, 101EDII and 125SD. Large 54mm elements maintain flat illumination across 35mm full format sensors. Fully multi-coated.

71FL + 7878 : 310mm F4.3
77EDII + 7878 : 400mm F5.2
101EDII + 7878 : 500mm F4.9
125SD + 7878 : 585mm F4.6

71FL + 7878 : 310mm F4.3
77EDII + 7878 : 400mm F5.2
101EDII + 7878 : 500mm F4.9
125SD + 7878 : 585mm F4.6

Finders



■ Dovetail Base [7755]
Finder dovetail base for BORG 6x30 finder bracket [0037] and Vixen or Vixen-compatible red-dot finders.



■ 6x30 Finder and Bracket [0037]
Finder scope with 6x magnification and 30mm aperture. 7-degree actual field of view with cross-hair.

Mounting Tubes



■ 80mm Plastic Tube Holder [5501]
Plastic tube holder for attachment of Series 80 telescopes to camera tripods. 1/4"-20 female thread at the bottom and male post at the top.



■ 80mm Plastic Tube Holder [5501] + Adapter E [5503]
Plastic tube holder for Series 80 scopes with BORG fork mount [3101]. 1/4"-20 female thread at the bottom and male post at the top.



■ Tube Band MDX [7083]
A pair of metal tube rings to hold Series 80 telescopes. One side has 1/4"-20 threaded holes at the center and two M6P1 threaded holes. The opposite side has a hole for 1/4"-20 or M6 screw.

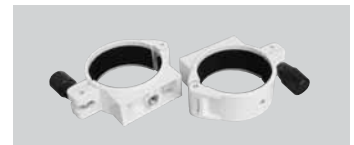

■ Tube Band for Mini BORG [7060]
A pair of metal bands for the Mini BORG Series. These include 1/4"-20 threaded holes at the bottom and an M6 threaded hole for [3105] at the top. Single bands are also available as [7061].



77EDII + EOS50D Shintaro Uchiumi

Digi-scoping & Series 115

Fork Mounts



■ Fork Mount [3101]

Fork mount with 3/8"-16 thread hole at the bottom. Used with [5503] or [3108]. Single-arm compact fork mount head may be used in alt-az or equatorial orientation with lightweight scopes such as BORG Series 80 or Mini Borg scopes. Use the Series 80 tube holder and adapter E set [5503] or universal attachment block [3108] for direct attachment of a scope with 1/4"-20 screw or Takahashi tube holders. The provided 3/8"-16 hole allows mounting on standard photographic tripods. The fork head may also be mounted on BORG's ultra-light SWII tripod using a special adapter as well as on 1/4"-20 tripods using a 3rd-party adapter available at camera stores. The mount may be moved rapidly by releasing the light gray clutch knobs or by turning the dark gray slow motion knobs. When used in equatorial orientation, a latitude scale aids in setting the fork tilt.

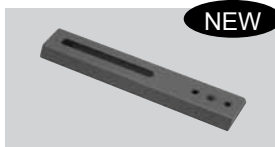

■ Dovetail Plate [3108]

150mm long adapter plate allows the use of a BORG lightweight single-arm fork mount [3101] with Mini BORG and Series 80 scopes, and adjustment of OTA position when a tube holder does not provide sufficient range of adjustment to achieve proper balance. Comes with an allen wrench and screws.

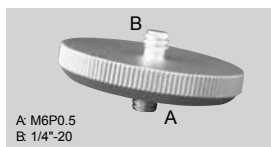

A: M6P0.5
B: 1/4"-20

■ Camera Mount Adapter [3105]

This camera mount adapter interfaces to a standard camera tripod socket (1/4-20) and the 6mm screw socket provided on Borg tube rings. This allows for the piggy-back mounting of cameras or other accessories via a ball-mount.



■ Adapter E [5502]

Additional part to convert [5501] to [5503]. It is user-installable.



■ Takahashi Mount Screw Set [5504]

Set of four screws to attach [5501] onto Takahashi mount.

Digi-scoping

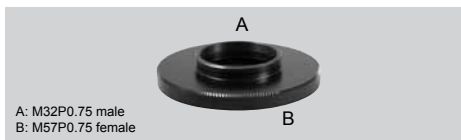

A: M32P0.75 male
B: M57P0.75 female

■ Nikon Scope to M57 [7163]

Allows use of BORG M57 accessories with Nikon spotting scopes.



A: M57P0.75 male

■ Drawtube Base Ring [9777]

Virtually eliminates the play of the Series 80 drawtube. This can be attached into the drawtube holder. This is useful in astronomical applications.

115φ Accessories

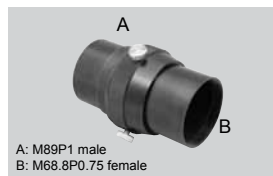

A: M89P1 male
B: M68.8P0.75 female

■ Drawtube N [8318]

Allows quick adjustment of focus over a wide range for Series 115 scopes. Helical focuser M/MDX and Feather Touch focusers via [FTF-BORG] can be used with this drawtube

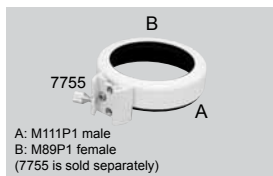

A: M111P1 male
B: M89P1 female
(7755 is sold separately)

■ 115φ Tube Finder Base N [8751]

Series 115 finder base tube to hold BORG finder dovetail base [7755].

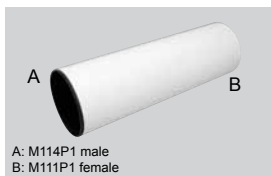

A: M114P1 male
B: M111P1 female

■ 115φ 360mm Tube [8360]

360mm long tube for 125SD.

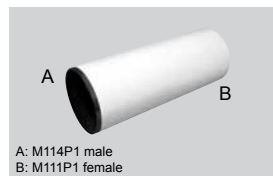

A: M114P1 male
B: M111P1 female

■ 115φ 295mm Tube [8295]

295mm long tube for 125SD.

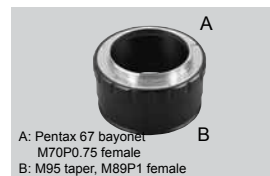

A: Pentax 67 bayonet
M70P0.75 female
B: M95 taper, M89P1 female

■ Pentax 6x7 Camera Mount [8567]

Used to attach a Pentax 6x7 body to BORG 4" helical focuser [8167].



71FL+E3 Noboru Nakagawa

Others

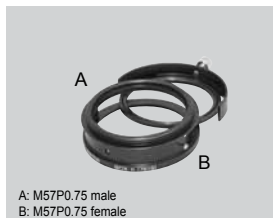

Filter Box [7519]
This filter holder from BORG makes changing filters a simple and painless task. The use of a shutter cable (not included) pops the filter carrier out of its holder without requiring the camera to be removed.



Filter Carrier [7518]
Extra filter carrier, which is intended for use with the [7519] filter box.



Erecting Mirror Diagonal [EMS-S]
High quality erecting mirror diagonal. Silvered mirrors increase reflection efficiency by 8%.



Double Mounting Tube [7513]
Double mounting tube for Mini BORG tube assembly. This allows attachment of the finder dovetail base [7755].



Padded Carrying Bag M [CB77L]
Padded carrying bag. Internal dimensions are 22"x5"x4.5".



Padded Carrying Bag L [CB101L]
Padded carrying bag. Internal dimensions are 26"x5"x4.5".



Camera Accessory Clamp [5556]
Has 2 camera attachment points and a 4 to 56mm wide clamp jaw. Intended to clamp to a table, tripod legs, or telescope counterweight bar.

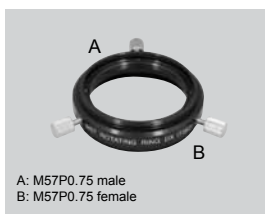

M57 Rotating Ring [7352]
An updated design of the older [7351] camera rotating ring. The [7352] rotating ring features smoother rotation and three setscrews for a secure lock.

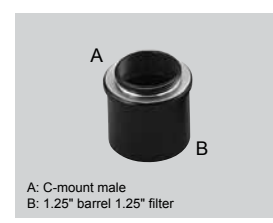

1.25" to C-mount AD [7511]
Allows insertion of c-mount threaded cameras into 1.25" eyepiece holders.

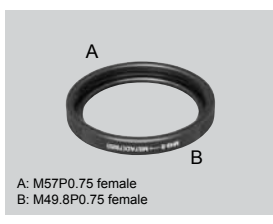

M49.8 to M57 AD [7920]
This adapter, used with focal reducers [7704], [7885], [7887], [7878], allows use of a variety of digital imaging equipment with BORG scopes via conversion to M57 threads.



Iris M57 [7057]
20 blades create a virtually round iris shape, which is useful when stopping down for greater depth of field. Adjustable from 5mm to 47mm diameter.

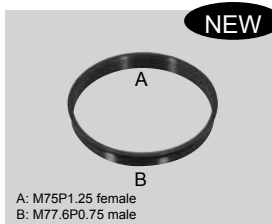

M75 to M77.6 AD [73001]
Replacement part used at the front of Series 80 tubes.

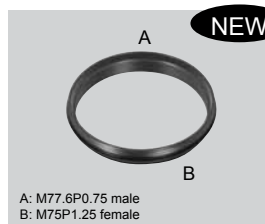

M77.6 to M75 AD [73002]
Allows connection of two Series 80 tubes. This is included in [7050] and [7025].

■ BORG Parts Specs (M: male, F: female, Unit: mm)

Part#	Description	Objective Side	Eyepiece Side	Length (Light Path)	OD (φ)	Page
4317	Helical Focuser	M36.4P1 M	1.25"	40 - 54 (35 - 49)	45.4	2
5002	Camera Mount	M49.8P0.75 F	—	(8.5 - 13)	60	3
5011						5
7000	Camera Mount AD	M55P0.75 M 52mm filter	M49.8P0.75 M	1.25 (5)	60	5
7057	Iris M57	M57P0.75 M	M57P0.75 F	18	71	14
7157	EOS→M57AD	EOS F	M57P0.75 F	16.2 (16.2)	64.8	3
7158	NK→M57AD	Nikon F	M57P0.75 F	15.5 (15.5)	60	3
7159	PK→M57AD	Pentax K F	M57P0.75 F	15.5 (15.5)	60	3
7163	Nikon FS to M57 AD	M32P0.75 M	M57P0.75 F	11 (6)	60	13
7205	M57 Drawtube	M57P0.75 M	M57P0.75 F	66 (22)	60	10
7214	1.4x Teleconverter DG	M57P0.75 M	M57P0.75 F	138 (40)	60	12
7215	1.4x Teleconverter GR	M57P0.75 M	M57P0.75 F	84 - 119 (59)	60	12
7314	1.25" Holder S	M36.4P1 M	1.25" sleeve	12 (8)	40	10
7315	1.25" Helical Focuser S	M36.4P1 M	1.25" sleeve M42P0.75 M	50 - 60 (45 - 55)	44	2
7316	1.25" Nosepiece AD	1.25" barrel	M36.4P1 F	26 (6)	40	10
7317	1.25" Holder	M36.4P1 M	1.25" sleeve	24 (20)	40	10
7352	M57 Rotating Ring	M57P0.75 M	M57P0.75 F	17 (13)	65	14
7356	1.25" to M57 AD	1.25" barrel 1.25" filter	M57P0.75 F M60P0.75 M	31 (7)	62	7
7357	M57 Metal Cap	M57P0.75 M M49P0.75 F	—	8 (4)	60	11
7358	Desiccant Holder	M49P0.75 M	—	40	50.6	11
7360	M43P1 to M57 AD	M43P0.75 M	M60P0.75 M M57P0.75 F	12 (8)	60	9
7361	M36.4 Metal Cap	M36.4P1 M	—	7.5 (4)	42	11
7362	M36.4 to M57 AD	M36.4P1 M	M57P0.75 F M60P0.75 M	12 (8)	58	9
7364	M57 to M36.4 AD	M57P0.75 M 52mm filter	M36.4P1 F	8 (4)	60	9
7410	SD-1 X	M57P0.75 M 52mm filter	M57P0.75 F	69 - 87 (65 - 83)	65	5
7416	M57 to M36.4P0.75 AD	M57P0.75 M	M36.4P0.75 M	12 (4)	60	7
7423	M42 to M36.4/42 AD	M42P0.75 F	M36.4P1 F M42P0.75 M	11 (11)	50	9
7424	SCT to M57/60	SCT 2" F	M57P0.75 F M60P0.75 M	14 (10)	64	9
7425	2" to M57/60	2" barrel 48mm filter	M57P0.75 F M60P0.75 M	43 (8)	64	10
7428	SCT to M68.8 AD	SCT F	M68.8P0.75 F	29 (29)	72	9
7430	M57 to M43	M57P0.75 M 52mm filter	M43P0.75 F	9 (5)	60	9
7457	M57 to M57 AD	M57P0.75 M	M57P0.75 M	12 (4)	60	9
7458	M57 to M57 ADII	M57P0.75 F	M57P0.75 F	10 (10)	60	9
7459	M57 to M57 ADIII	M57P0.75 F	M57P0.75 F	18 (18)	65	9
7460	M60 to M60	M60P0.75 F	M60P0.75 F	10 (10)	64	9
7502	M57→2" SCT AD	M57P0.75 M 52mm filter	SCT M	19 (5)	61	9
7507	M68.8 to M57	M68.8P0.75 M	M57P0.75 F	12 (7)	78	9
7510	M60→M57AD	M57P0.75 M 52mm filter	M60P0.75 M 55mm filter	15 (5)	64	9
7511	1.25" to C-mount	1.25" barrel	C-mount M	32 (28)	34	14

Part#	Description	Objective Side	Eyepiece Side	Length (Light Path)	OD (φ)	Page
7522	M57→M36.4/42AD	M57P0.75 M 52 filter	M36.4P1 F M42P0.75 M	12 (9/5)	60	9
7523	M57→M42P1AD	M57P0.75 M	M42P1 M M36.4P1 F	12.5 (8.5)	60	9
7524	M42P1→M57/60AD	M42P1 F	M57P0.75 F M60P0.75 M	9 (5)	62.5	9
7525	M42P1→M36.4/M42AD	M42P1 F	M36.4P1 F M42P1 M	9 (5)	47	9
7526	M42P1→C-mountAD	M42P1 F	C-mount M	9 (6)	48	3
7527	C-mount→M42P1AD	C-mount F	M42P1 M	7 (3.5)	48	3
7528	M42P0.75→M57AD	M42P0.75 F	M57P0.75 F	8 (8)	60	9
7557	KowaDA4 to M57	M57P0.75 M	M60.8P0.75 M	100 (60)	60	13
7757	M57 Helical Focuser S	M57P0.75 M	M57P0.75 F	23 - 33 (19 - 29)	67	2
					ID50.8	
7758	M57 Helical Focuser MDX	M57P0.75 M	M57P0.75 F	30 - 47 (26 - 43)	68	2
					ID50.8	
7801	M77.6→M68.8AD	M77.6P0.75 M	M68.8P0.75 F	9 (6)	80	11
7835	Helical Focuser M	M68.8P0.75 M	M57P0.75 F M60P0.75 M	71 - 91 (63 - 83)	76	2
					ID56	
7839	M42(T-thread) Helical Focuser	M42P0.75 F	M42P0.75 M	21 - 31 (15 - 25)	60	2
7840	M42P1 Helical Focuser S	M42P1 F	M42P1 M	17 - 24 (11 - 18)	60	3
7841	M42 Helical Focuser L	M42P1 F	M42P1 M	33 - 53 (27 - 47)	60	3
7842	M42 Helical Focuser	M42P1 F	M42P1 M	21 - 31 (15 - 25)	60	3
7843	M42P1→M49.8AD	M42P1 F	M49.8P0.75 M	5 (1.5)	54	3
7844	M42P1→M39AD	M39P1 F	M42P1 M	5 (1.5)	54	3
7852	M42P1→M39ADII	M42P1 F	M39P1 M	20 (17)	56	3
7855	M42P0.75→M42P1AD	M42P0.75 F	M42P1 M	10 (6)	60	9
7856	M42P1→M42P0.75AD	M42P1 F	M42P0.75 M	10 (6)	60	9
7857	M57 Helical Focuser	M57P0.75 M	M57P0.75 F M60P0.75 M	53 - 68 (49 - 64)	63	2
					ID47	
7860	M57 Helical Focuser LII	M57P0.75 M	M57P0.75 F	50 - 86 (46 - 82)	63	2
					ID51	
7865	M68.8→65φ	M68.8P0.75 M	65φ barrel	19 (15)	74.5	14
7866	Reducer 0.66×DGT	M57P0.75 M 49mm filter	M49.8P0.75 M	72 (65)	60	12
7878	Reducer 0.78×DGT	M57P0.75 M	M57P0.75 F	49 (45)	60	12
7885	Reducer 0.85×DGT	M57P0.75 M 52mm filter	M49.8P0.75 M	22 (10)	60	12
7901	M60→M57/60AD (Vixen ED/FD)	M60P0.75 M M57P0.75 F	M57P0.75 F M60P0.75 M	10 (3)	64	7
7910	M47→M57/60AD (Tak FC50/60)	M47P0.75 F	M57P0.75 F M60P0.75 M	12 (8)	63	7
7911	M56→M57/60AD (Tak FS60C/FS78)	M56P0.75 F	M57P0.75 F M60P0.75 M	10.5 (7)	63	7
7912	M72→M57/60AD (Tak FS128/TOA/TSA)	M72P1 M 58mm filter	M57P0.75 F M60P0.75 M	12 (4)	75	7
7914	M56→M57/60ADII (Kenko SE80ED)	M56P1 F	M57P0.75 F M60P0.75 M	28	70	7
7920	M49.8→M57AD	M49.8P0.75 F	M57P0.75 F	8 (4)	64	14
7921	M49.8 Extension S	M49.8P0.75 F	M49.8P0.75 M	8.2	60	5
7922	M49.8 Extension M	M49.8P0.75 F	M49.8P0.75 M	21.5	60	5
7923	M49.8→M49.8 A DSS	M49.8P0.75 M	M57P0.75 M	5	60	5
9857	MMF-1	M57P0.75 M	M42P0.75 M	40	-	10
9868	LMF-1	M68.8P0.75 M	M57P0.75 F	50	-	10

■ BORG Screws

Part #	Size	Description
1600	M6P0.5φ10	7317,4603,4604
1601	M3P0.5φ6M	7835,7837
1602	M6P0.5φ14	74102
1603	M4P1φ14	74102
1604	M4P1φ10	7351
1605	M6P0.5φ18	7835,7837, 6160, 7749, 8167, 7202, 7205
1606	M6P0.5φ14D	7504,7505,7508,7509

Part #	Size	Description
1607	M3P0.5φ6P	7315
1608	M4P1φ6P	7758,7860
1610	M3P0.5φ8	4317,7314,7315,7501,7506
1611	M4P1φ8	7857
1612	M6P1φ10	1401
1613	M6P1φ18	8167
1614	M6P1φ14	8167
1615	M3P0.5φ8L19	7267
1616	M3P0.5φ 8L18	7397

Manufacturer

TOMYTEC Co., Ltd.
 4-20-11 Aoto Katsushika-ku Tokyo Japan
 Tel: 03-3603-1310

Worldwide Distributor
Astro Hutech

23505 Crenshaw Blvd., #225
 Torrance CA 90505
 Tel: 310-325-5511 (877-BUY-BORG)
 www.astrohutech.com

Regional Distributor

SCS Astro
 1 Tone Hill, Wellington Somerset TA21 0AU, United Kingdom
 Tel: (44)1823-665510
 www.scsastro.co.uk

Caution

Do not look directly at the sun through a telescope or its finder. Doing so will result in blindness. Please read the "Safety Instructions" carefully for proper use. Improper use of the product could lead to severe and permanent physical damage.